

MEANDER

DESIGN HANNES ÅSTRÖM, 2021

Meander är ett organiskt uppbyggt sittmöbelsystem i trä, som kan byggas till olika former och anpassas efter rummets specifika förutsättningar. Våren 2020 gjorde Hannes sitt kandidatexamensarbete på Malmstens Linköping Universitet. Han fick då uppdraget från Karl Andersson & Söner att formge ett sittmöbelsystem i trä med flexibel utformning som kunde passa i alla möjliga rum. Han ville ge möbelen ett lugnt uttryck med horisontalt slingrande linjer likt en meander, en flod som äter sig fram genom ett landskap. Därav namnet.

UTFÖRANDE

Meander består av rak soffa och bänk, med eller utan armstöd, i tre olika längder, samt kurvade delar i 45 och 90 graders vinkel. Soffans rygg är böjd antingen som en inner- eller ytterdel. Alla gavlar är förberedda för förankring i golv. Träslagen är ek, ask, standardbetser på ask och vitpigmenterad ek eller ask. Meander levereras monterad.

Om skada uppstår på sits eller rygg går det enkelt att skruva loss med handverktyg och byta ut eller slipa om.

TILLBEHÖR

Kopplingsbeslag, pop-up bord och eluttag.

ANGE VID BESTÄLLNING

Artikelnummer och utförande.

CERTIFIKATIONER/TESTER

EN 16139:2013

Möbelfakta

Meander is an organically shaped modular seating system in wood. Modules can be combined to create a variety of shapes that ensure Meander is able to adapt to the specific conditions in any given space. After graduating from Malmstens Linköping University with a Bachelor's degree in the spring of 2020, Hannes Åström was commissioned by Karl Andersson & Söner to design a wooden seating system whose modular construction was flexible enough to be used in rooms of all shapes and sizes. Hannes sought to give his design a restful character with gently curved horizontal lines reminiscent of a meandering river that flows calmly through the landscape. Hence the name.

EXECUTION

Meander comprises a straight sofa and bench, with or without armrest, in three different lengths, complemented by curved modules with 45° and 90° angles. The sofa's backrest follows the curved inner or outer lines of the sofa. All end sections are prepared so that they can be anchored to the floor. Choose from oak, ash, standard stains on ash, or white glaze on oak or ash. Meander is supplied assembled.

Any damage sustained to seat or backrest can simply be repaired by unscrewing the element in question with a hand tool and replacing it or sanding down the affected area.

ACCESSORIES

Link fittings, pop-up table and electric outlets.

WHEN ORDERING PLEASE ENTER

Item number and execution.

CERTIFICATIONS/TESTS

EN 16139:2013, Möbelfakta



TRÄSLAG WOOD



STANDARDBETSER STANDARD STAINS



VITPIGMENT WHITE GLAZED



SOFFA RAK SOFA STRAIGHT

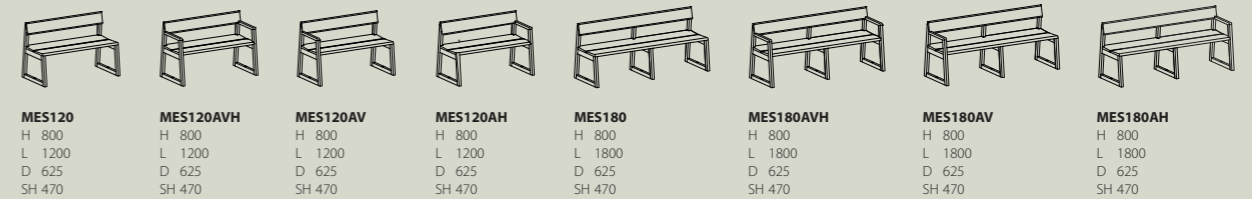

MES120
H 800
L 1200
D 625
SH 470

MES120AVH
H 800
L 1200
D 625
SH 470

MES120AV
H 800
L 1200
D 625
SH 470

MES120AH
H 800
L 1200
D 625
SH 470

MES180
H 800
L 1800
D 625
SH 470

MES180AVH
H 800
L 1800
D 625
SH 470

MES180AV
H 800
L 1800
D 625
SH 470

MES180AH
H 800
L 1800
D 625
SH 470

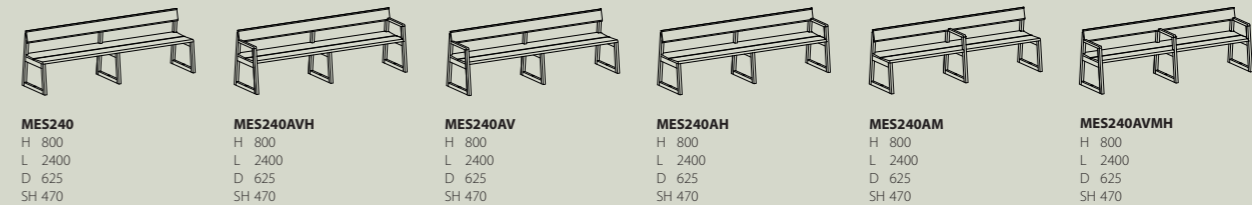

MES240
H 800
L 2400
D 625
SH 470

MES240AVH
H 800
L 2400
D 625
SH 470

MES240AV
H 800
L 2400
D 625
SH 470

MES240AH
H 800
L 2400
D 625
SH 470

MES240AM
H 800
L 2400
D 625
SH 470

MES240AVMH
H 800
L 2400
D 625
SH 470

SOFFA SOFA INNER 45°



MES45I
H 800
L 1225/750
D 625
SH 470

MES45IAV
H 800
L 1220/750
D 625
SH 470

MES45IAH
H 800
L 1220/750
D 625
SH 470

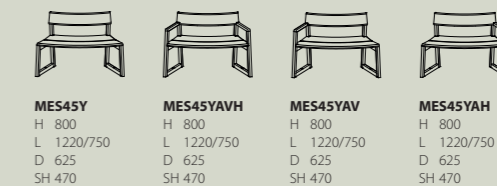

MES45Y
H 800
L 1220/750
D 625
SH 470

MES45YAVH
H 800
L 1220/750
D 625
SH 470

MES45YAV
H 800
L 1220/750
D 625
SH 470

MES45YAH
H 800
L 1220/750
D 625
SH 470

SOFFA SOFA INNER 90°

Endast för koppling eller fästas i golv
Only for connecting or secured into floor



MES90I
H 800
L 1350/475
D 625
SH 470

MES90IAV
H 800
L 1350/475
D 625
SH 470

MES90IAH
H 800
L 1350/475
D 625
SH 470



MES90Y
H 800
L 1350/475
D 625
SH 470

MES90YAVH
H 800
L 1350/475
D 625
SH 470

MES90YAV
H 800
L 1350/475
D 625
SH 470

MES90YAH
H 800
L 1350/475
D 625
SH 470

TILLBEHÖR ACCESSORIES

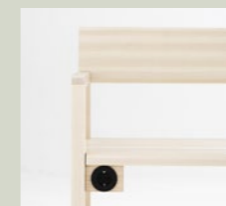

MEEL
1 eluttag inkl. 2 meter kabel. Placeras nära ben i framkant under sits. Gäller för SE, NO, FIN, DE, NL.
1 electrical outlets incl. 2 meters cable. Placed close to legs in front under the seat. For SE, NO, FIN, DE, NL.



MEPUB
Ø 260 mm. Massiv trä, metall i svart finstruktur. Ø 260 mm. Solid wood, metal black powder coat.

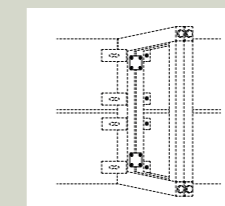

MEKB
Kopplingsbeslag i metall placerad under sits.
Link fittings metal placed under the seat.



Armstöd
Armrest

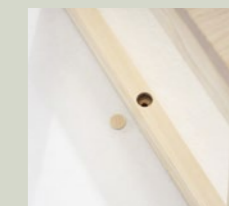

Förankring i golv
Secured to the floor

DETALJ DETAIL

BÄNK RAK BENCH STRAIGHT

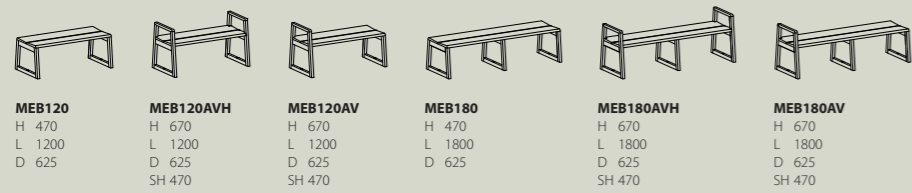

MEB120
H 470
L 1200
D 625

MEB120AVH
H 670
L 1200
D 625
SH 470

MEB120AV
H 670
L 1200
D 625
SH 470

MEB180
H 470
L 1800
D 625

MEB180AVH
H 670
L 1800
D 625
SH 470

MEB180AV
H 670
L 1800
D 625
SH 470

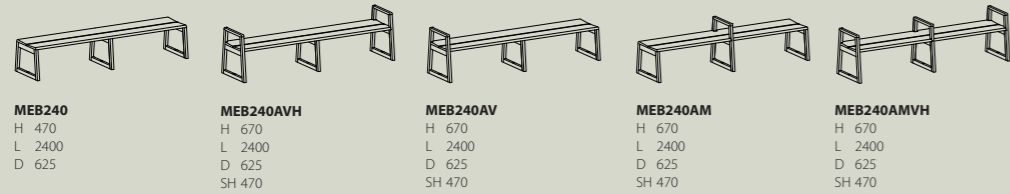

MEB240
H 470
L 2400
D 625

MEB240AVH
H 670
L 2400
D 625
SH 470

MEB240AV
H 670
L 2400
D 625
SH 470

MEB240AM
H 670
L 2400
D 625
SH 470

MEB240AMVH
H 670
L 2400
D 625
SH 470

BÄNK BENCH 45°

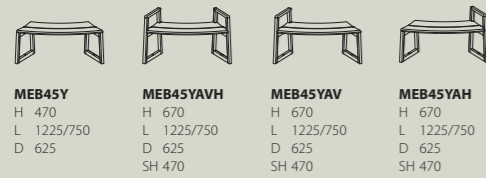

MEB45Y
H 470
L 1225/750
D 625

MEB45YAVH
H 670
L 1225/750
D 625
SH 470

MEB45YAV
H 670
L 1225/750
D 625
SH 470

MEB45YAH
H 670
L 1225/750
D 625
SH 470

BÄNK BENCH 90°

Endast för koppling eller fästas i golv
Only for connecting or secured into floor

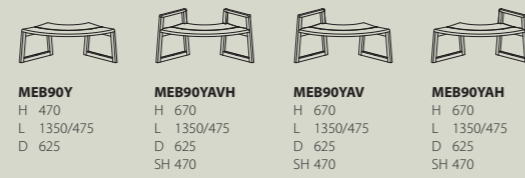

MEB90Y
H 470
L 1350/475
D 625

MEB90YAVH
H 670
L 1350/475
D 625
SH 470

MEB90YAV
H 670
L 1350/475
D 625
SH 470

MEB90YAH
H 670
L 1350/475
D 625
SH 470

FÖRSLAG SUGGESTIONS

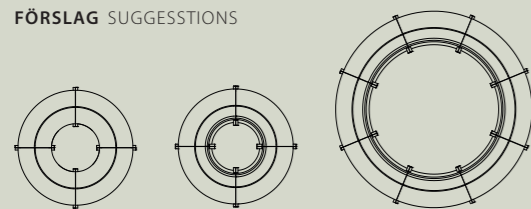

4 x MEB90Y
Ø 1920/650

4 x MES90Y
Ø 1920/650

8 x MES45Y
Ø 3220/1940

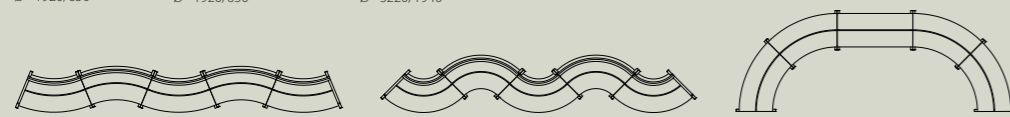

1xMES45YAV, 2xMES45I, 1xMES45Y, 1xMES45YAH
L 5175
W 740

1xMES90YAV, 2xMES90I, 1xMES90Y, 1xMES90YAH
L 5005
W 920

1xMEB120, 4xMEB45Y
L 3940
W 1830

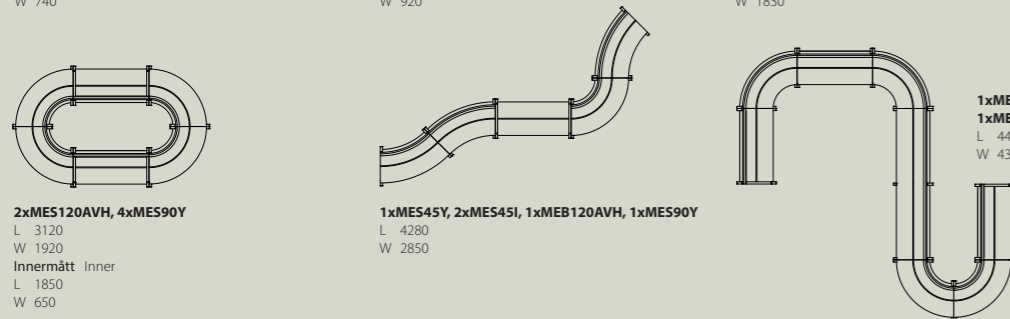

2xMES120AVH, 4xMES90Y
L 3120
W 1920
Innermått Inner
L 1850
W 650

1xMES45Y, 2xMES45I, 1xMEB120AVH, 1xMES90Y
L 4280
W 2850

1xMES120AV 2xMES90I, 1xMES120, 1xMES240, 2xMES90Y, 1xMES120AH
L 4420
W 4330





Sofa Sofa MES45Y, MES45I, Kopplingsbeslag Linkfitting MEKB



Sofa Sofa 2xMES45I, Kopplingsbeslag Linkfitting MEKB | Bord Table CAP





Soffa Sofa MES120 | Bord Table LOCUS | Stol Chair COLO CHAIR | Tidskriftsställ Magazine shelf FRONT LIST



Bänk Bench 2x MEB90Y, 1x MEB90UAVH, 1x MEB90YAV | CAP PODIUM | Klädhängare Coat hanger NEST



Soffa Sofa 2 x MES90Y | Tidskriftsställ Magazine shelf ELL | CAP PODIUM



Soffa Sofa ME180 L1800 | Bord Table WOODWORK | Pall Stool SHELL | Skål Bowl LOLLIPOP

PROVER SAMPLES MEANDER

Tänk på att de tryckta proverna kan skilja sig i färg, struktur och nyans jämfört med levererad produkt.
Keep in mind that the printed samples can differ in color, texture and shades compared with delivered product.

TRÄSLAG WOOD

Ytbehandling är klarlack i glansvärde 18, halvmatt. Alternativa ytbehandlingar olja, olja + lack kan erbjudas.
Treated with clear lacquer in a no. 18 semi-matt finish. Other available finishes are oil or oil + lacquer.



.10 Ek Oak



.30 Ask Ash

STANDARDBETSER STANDARD STAINS

Bets på ek eller ask om inget annat anges. Topplack är klarlack i glansvärde 18, halvmatt. Specialbets enligt insänt prov kan erbjudas.
Stain on oak or ash if not otherwise specified. Top coat of clear lacquer in a no. 18 semi-matt finish. Specialist stains in accordance with samples sent to us are also available.



.11 Svart bets
Black stain



.12 Wenge bets
Wenge stain



.13 Snövit bets
Snow white stain



.14 Rödbrun bets
Red-brown stain



.15 Grön bets
Green stain

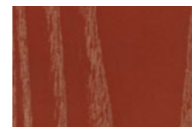

.16 Röd bets
Red stain



.17 Blå bets
Blue stain



.18 Brun bets
Brown stain



.19 Grå bets
Grey stain



.20 Antracit bets
Anthracite stain

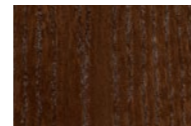

.21 Valnöt bets
Walnut stain

VITPIGMENT WHITE GLAZED

Vitpigment på ek eller ask om inget annat anges. Topplack är klarlack i glansvärde 18, halvmatt.
White glazed on oak or ash if not otherwise specified. Top coat of clear lacquer in a no. 18.



.25 Vitpigmenterad ask
White glazed ash



.26 Vitpigmenterad ek
White glazed oak



KARL ANDERSSON & SÖNER
SINCE 1898

HANDMADE IN HUSKVARNA. SINCE 1898.

Karl Andersson & Söner. Rosendalagatan 6, SE-561 34 Huskvarna, Sweden
+46 (0)36 13 25 30. info@karl-andersson.se

Showrooms

Studio B3. Barnhusgatan 3. Stockholm. +46 (0)8 21 42 31
Studio L6. Lasarettsgatan 6. Göteborg. +46 (0)31 13 83 90

karl-andersson.se