



FRONT LIST LEDGE	2
FRONT PLANT	8
FRONT HYLLA SHELF	9
FRONT PANEL	16
FRONT FÖRVARING STORAGE	20
FRONT FRISTÅENDE FREE STANDING	22
FRONT MONTERSKÅP DISPLAY CABINET	25
FRONT TAVLA BOARD	26
FRONT KLÄDHÄNGARE COAT RACK	28
PROVER SAMPLES	30

FRONT

DESIGN SKALA DESIGN/LASSE PETERSSON LENNART NOTMAN, 2004-2012

Front presenterades år 2004 som ett enkelt rakt tidskriftsställ som skruvas i vägg. Under årens lopp har Front vuxit och blivit ett omfattande exponeringssystem bestående av tidskrifts-, magasin-, och tavellist, hylla, klädhängare, glaslåda för växter, dekorationer eller exponering, tavla för pappersark eller affisch, panel med olika funktioner som skrivtavla, anslagstavla, spegel, tidskrifts- och broschyrställ, förvaring för extra tidskrifter/broschyrer, monterskåp och fristående skärm. Fördelen med Front är att du kan möblera med samma produkt för olika användningsområde. Front möbleras i hotell, i väntrum, i arbets-, konferens- och lunchrum, skolor, museum, bibliotek, ambassader, hemma i kök, hall eller i sovrum.

Front was presented in 2004 as a simple straight magazine strip that is screwed into the wall. Over the years, the Front has grown into a extensive display system consisting of periodicals, magazine, and picture moldings, shelves, hangers, glass planter, decorations or display, plate for paper or poster panel with various features like whiteboard, bulletin board, mirror, magazine and brochure racks, storage for extra magazines/brochures, both cabinets and freestanding screen. The advantage of the Front display system is that you can decorate with the same product for different applications. Front is furnished in hotels, in waiting rooms, in work, conference, canteens, schools, museums, libraries, embassies, at home in the kitchen, hallways or bedrooms.

FRONT LIST LEDGE

UTFÖRANDE

Består av rak eller vinklad list i massiv ek, björk, standardfärger och standardbetser på ek. Ytbehandling klarlack. Skruvas på vägg. Härdat klarglas i höjderna 32 mm (ej för vinklad list), 150 mm (=A5) och 230 mm (=A4). Finns även i plexiglas mot tillägg. Specialmått och andra utförande efter förfrågan. Listerna används för exponering av tidning, magasin, broschyr, tavla, plansch, fotografi.

TILLBEHÖR

Avdelare i massiv trä som sätts på glaset för indelning i fack.

ANGE VID BESTÄLLNING

Artikelnummer, längd på list, höjd på glas och utförande.

CERTIFIKATIONERT/TESTER

Möbelfakta.

EXECUTION

Straight or slope ledge in solid oak, birch, standard colors and standard stains on oak. Finish clear lacquer. Secured directly to the wall. Tempered clear glass in height 32 mm (not for sloping ledge), 150 mm (=A5) and 230 mm (=A4) comes as standard. Plexi glass made-to-measure sizes other types of wood, colors and surface treatment are available on request. Ledges are used for display of magazines, leaflets, posters, photos.

ACCESSORIES

Dividers in solid wood that slot on top of the glass fronts to divide each shelf into compartments.

WHEN ORDERING, PLEASE ENTER

Item number, length of ledge, height of glass and execution.

CERTIFICATIONS/TESTS

Möbelfakta.



TRÄSLAG WOOD



STANDARDFÄRGER STANDARD COLORS



STANDARDBETSER STANDARD STAINS



ARTIKLAR ITEMS

*Längd Length 250, 500, 1000, 1500, 2000 mm

GH=Glashöjd Glass height

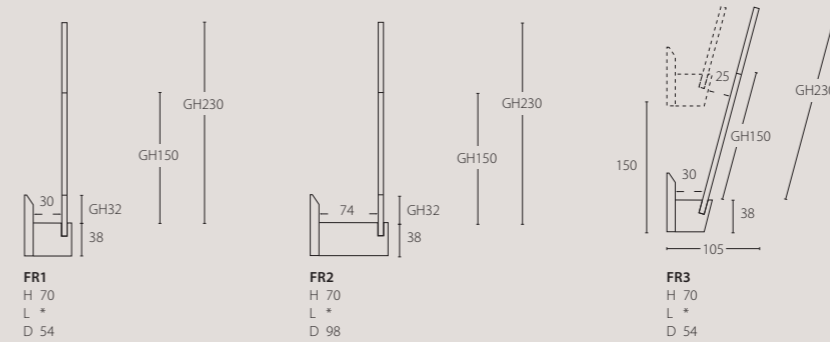

TILLBEHÖR ACCESSORIES

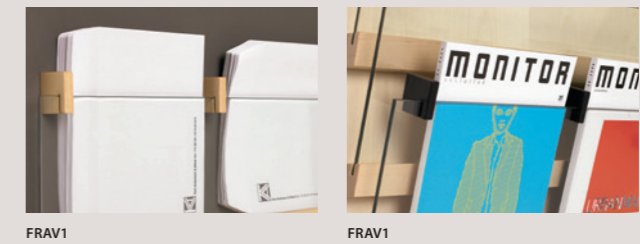
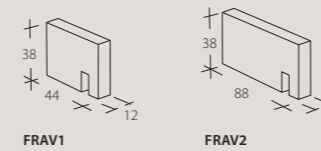

Exponeringslist Display ledge FR3 100 L 1000 H 230 | Bord Table CROSS | Pall Stool PASTILLO



List Ledge FR2 L 500 GH 32, L 500 GH 150 | Hylla Shelf FRONT | Sitt-ö Stool STEELO



Exponeringslist Display ledge FR1 200 L 2000 GH 230



Exponeringslist Display ledge FR1 100 L 1000 GH 230 | Bord Table MILL | Fåtölj från Easy chair from Swedese



Exponeringslist Display ledge FR2 100 L 1000 GH 32 | Byrå Chest of drawers MAY



Exponeringslist Display ledge FR2 50 L 500 GH 32 GH 150, FR1 150 L 1500 GH 150 | Plant, Hylla Plant, Shelf FRONT | Byrå Chest of drawers MAY

FRONT PLANT

UTFÖRANDE

Består av rak list i djup 98 mm som skruvas i vägg. I spåret sätts en glaslåda i vit eller transparent glas i längd 500 mm. Listen är i massiv ek, björk, standardfärger och standardbetser på ek. Ytbehandling klarlack. Glaslådan kan användas för växter, ljus, dekorationer eller som exponering.

ANGE VID BESTÄLLNING

Artikelnummer, utförande på list och glaslåda.

EXECUTION

The glass planter, 500 mm long in clear or white glass, is used together with a 98 mm deep display ledge for a wall-mounting. Display ledge of solid wood in oak, birch, standard colors and standard stains on oak. Finish clear lacquer. Use Front plant for floral decorations, or as the basis for all sorts of other decorative displays.

WHEN ORDERING, PLEASE ENTER

Item number, length of ledge and execution of ledge and glass box.

FRONT HYLLA SHELF

UTFÖRANDE

Massiv ek, björk, standardfärger och standardbetser på ek. Samtliga hyllor skruvas rakt in i vägg, djup 250 mm förstärks även med dold konsol. Specialmått och andra utförande efter förfrågan.

ANGE VID BESTÄLLNING

Artikelnummer, längd och utförande.

EXECUTION

Solid oak, birch, standard colors and standard stains on oak. All sizes are secured directly to the wall. The 250 mm deep shelf is reinforced with a hidden bracket. Special sizes and other finishes upon request.

WHEN ORDERING, PLEASE ENTER

Item number, length and execution.

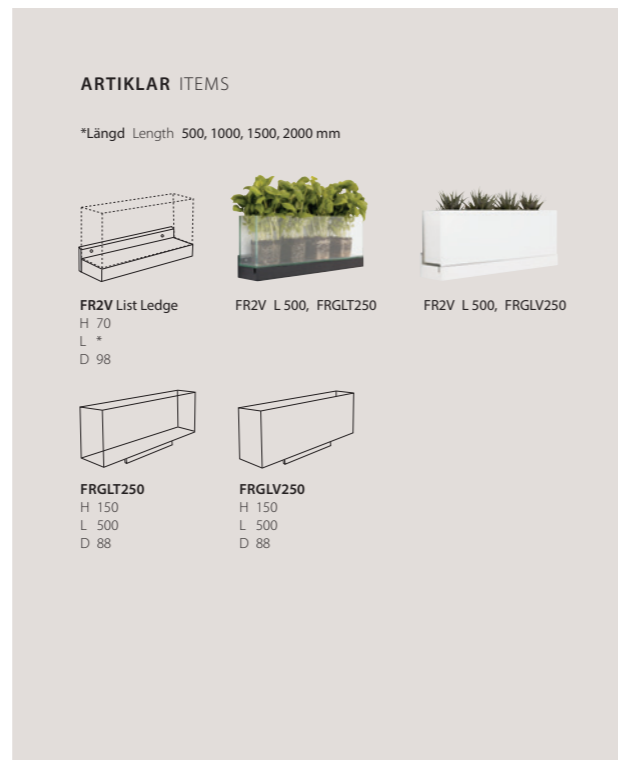

TRÄSLAG WOOD



STANDARDFÄRGER STANDARD COLORS



STANDARD BETSER STANDARD STAINS

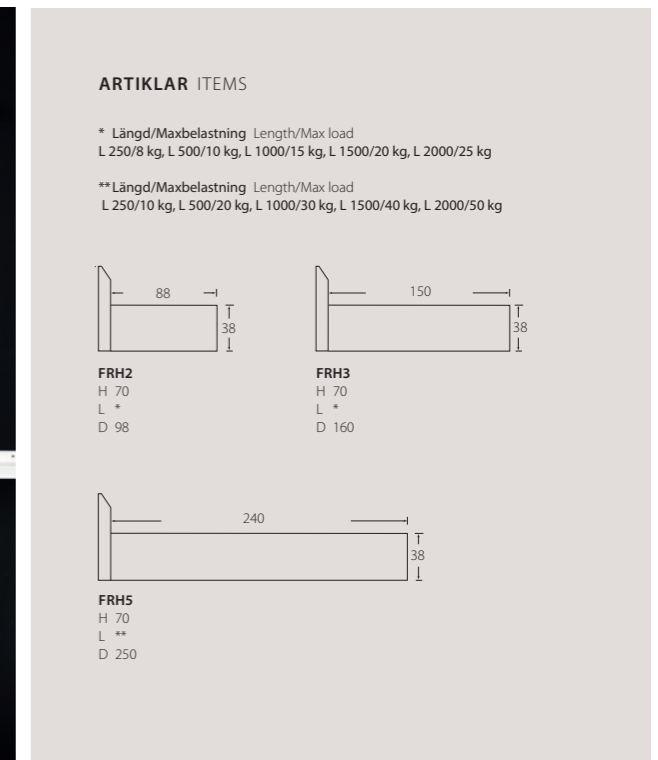

TRÄSLAG WOOD



STANDARDFÄRGER STANDARD COLORS



STANDARD BETSER STANDARD STAINS





FRONT Hylla Shelf FRH5 L 1500 | FRONT List Ledge FR1 L 1500 GH 150 | FRONT Plant FR2V L 1500+FRGLT250 | Bord Table CAP CA3 60 | Pall Stool SHELL SHP70T



Hylla Shelf FRH5 150 L 1500 | Skåp Cabinet STOW



Hylla Shelf FRH5 25 L 250 | Bord Table ponoq



Hylla Shelf FRH5 L 1500 | Bord Table PRESS | Stol Chair TRIPPO

FRONT PANEL

UTFÖRANDE

Front panel används som tidskrifts-, broschyrställ, spegel, anslagstavla, skrivtavla eller en kombination av dessa. Rygg finns att välja mellan raka eller vinklade lister, magnetisk whiteboard inklusive ett antal magneter, Bulletin Board 2204, klädd i tyg Europost från Gabriel och spegel. Specialmått och andra utförande efter förfrågan. Panelen hängs på vägg med metallist. Listerna i massivt trä och rygg i MDF av faner i ek, björk, standardfärger* och standardbetsar*. Ytbehandling klarlack. Härdat klarglas i höjderna 32, 150 (=A5) or 230 (=A4) mm. Som tillägg finns plexi-glas. Istället för glas till magnetisk whiteboard eller anslagstavla kan man välja 15 mm hög träavslut.

* Observera! För rygg i magnetisk whiteboard och Bulletin Board 2204 finns kantlist endast i trä, svart eller vit.

TILLBEHÖR

Avdelare i massiv trä som sätts på glasets för indelning i fack. Extra magneter till whiteboard.

ANGE VID BESTÄLLNING

Artikelnummer, glashöjd, färgnummer på tyget Europost och utförande.

CERTIFIKATIONER/TESTER

Möbelfakta.

EXECUTION

Front panel is a magazine rack, a brochure stand, a mirror, a writing and noticeboard – or a combination of all these functions. You can choose the back of straight or sloping ledge, magnetic whiteboard included some magnets, Bulletin Board 2204, covered in any color of fabric Europost from Gabriel and mirror. Special sizes and other finishes upon request. It is secured to the wall using a metal rail. The ledges in solid wood and back in MDF of veneer in oak, birch, standard colors* and standard stains*. Finish clear lacquer. Tempered clear glass in height 32, 150 (=A5) or 230 (=A4) mm as standard and plexi glass upon request. Instead of glass for magnetic whiteboard and notice board you can choose of 15 mm wood end.

* Note! Edge of magnetic whiteboard and Bulletin Board 2204, on back, is only available in wood, black or white.

ACCESSORIES

Dividers in solid wood that slot on top of the glass fronts to divide each shelf into compartments.

WHEN ORDERING, PLEASE ENTER

Item number, height of glass, color of Europost, execution.

CERTIFICATIONS/TESTS

Möbelfakta.



ARTIKLAR ITEMS

- (1) B= Bulletin Board 2204
Bulletin Board 2204
- (2) K= Klädd i tyg Europost
Covered in fabric Europost
- (3) S= Spegel
Mirror
- (4) T= Träpanel med lister
Wood panel incl. ledges
- (5) W= Magnetisk whiteboard
Magnetic whiteboard

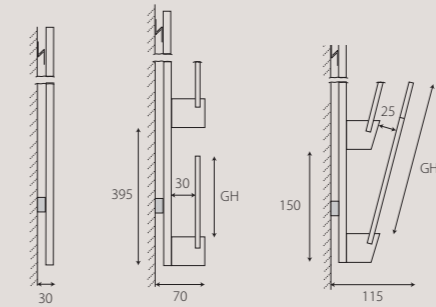

RAK LIST STRAIGHT LEDGE
GH = Glashöjd 32, 150, 230 mm eller träavslut 15 mm för anslagstavla och whiteboard.
GH = Glass height 32, 150, 230 mm or wood end 15 mm for pin-, and whiteboard.

VINKLAD LIST SLOPING LEDGE
GH = Glashöjd Glass height 150, 230 mm

Höjd Hight 800 mm

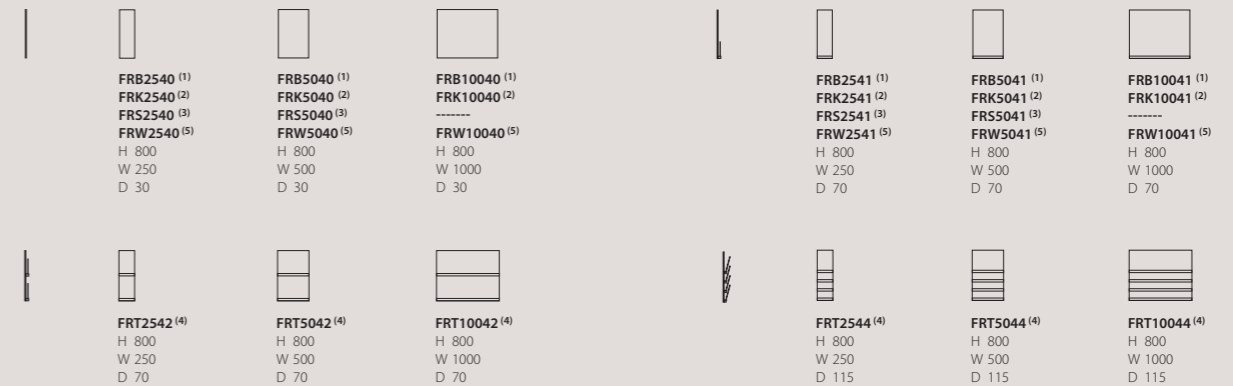



Höjd Hight 1140 mm



ARTIKLAR ITEMS

- (1) B=Bulletin Board 2204 Bulletin Board 2204
- (2) K=Klädd i tyg Europost Covered in fabric Europost
- (3) S=Spegel Mirror
- (4) T=Träpanel med lister Wood panel incl. ledges
- (5) W=Magnetisk whiteboard Magnetic whiteboard

Höjd Height 1550 mm

 FRB2590 ⁽¹⁾ FRK2590 ⁽²⁾ FRS2590 ⁽³⁾ FRW2590 ⁽⁵⁾ H 1550 W 250 D 30	 FRB5090 ⁽¹⁾ FRK5090 ⁽²⁾ FRS5090 ⁽³⁾ FRW5090 ⁽⁵⁾ H 1550 W 500 D 30	 FRB10090 ⁽¹⁾ FRK10090 ⁽²⁾ ----- FRW10090 ⁽⁵⁾ H 1550 W 1000 D 30	 FRB2591 ⁽¹⁾ FRK2591 ⁽²⁾ FRS2591 ⁽³⁾ FRW2591 ⁽⁵⁾ H 1550 W 250 D 70	 FRB5091 ⁽¹⁾ FRK5091 ⁽²⁾ FRS5091 ⁽³⁾ FRW5091 ⁽⁵⁾ H 1550 W 500 D 70	 FRB10091 ⁽¹⁾ FRK10091 ⁽²⁾ ----- FRW10091 ⁽⁵⁾ H 1550 W 1000 D 70
 FRB2593 ⁽¹⁾ FRK2593 ⁽²⁾ FRW2593 ⁽⁵⁾ H 1550 W 250 D 115	 FRB5093 ⁽¹⁾ FRK5093 ⁽²⁾ FRW5093 ⁽⁵⁾ H 1550 W 500 D 115	 FRB10093 ⁽¹⁾ FRK10093 ⁽²⁾ FRW10093 ⁽⁵⁾ H 1550 W 1000 D 115	 FRT2594 ⁽⁴⁾ H 1550 W 250 D 70	 FRT5094 ⁽⁴⁾ H 1550 W 500 D 70	 FRT10094 ⁽⁴⁾ H 1550 W 1000 D 70
 FRT2599 ⁽⁴⁾ H 1550 W 250 D 115	 FRT5099 ⁽⁴⁾ H 1550 W 500 D 115	 FRT10099 ⁽⁴⁾ H 1550 W 1000 D 115			

TILLBEHÖR ACCESSORIES

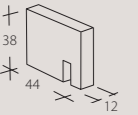
FRAV1

FRM1 Magnet Magnets



Anslagstavla Pinboard FRK10041 | Tidskriftställ Magazine shelf FRT10042 | Bord Table CROSS



Magnetisk Whiteboard FRW5041 | Bord Table BUFF | Fåtölj Easy chair Swedese Anslagstavla Pinboard FRB10091 | Bord Table MILL | Stol Chair ØRESUND

FRONT FÖRVARING STORAGE

UTFÖRANDE

Ryggen i trä med monterade raka eller vinklade lister för tidningar, broschyrer och magasin. Bakom finns det utrymme för extra förvaring. Lister är i massiv trä och rygg i MDF av faner i ek, björk och standardfärger. Ytbehandling klarlack. Härdat klarglas i höjd 230 mm. Som tillägg finns plexiglas. Förvaringen hängs på vägg med metallist. Specialmått och andra utförande efter förfrågan.

TILLBEHÖR

Avdelare i massiv trä som sätts på glaset för indelning i fack.

ANGE VID BESTÄLLNING

Artikelnummer och utförande.

EXECUTION

Back of wood with straight or sloping ledges for magazines and brochures. Behind extra storage spaces. It is secured to the wall using a metal rail. Ledges in solid wood and back in MDF veneer of oak, birch and standard colors. Finish clear lacquer. Tempered clear glass in height 230 mm (=A4) as standard. Plexi glass, special sizes and other finishes upon request.

ACCESSORIES

Dividers in solid wood that slot on top of the glass fronts to divide each shelf into compartments.

WHEN ORDERING, PLEASE ENTER

Item number and execution.



TRÄSLAG WOOD



STANDARDFÄRGER STANDARD COLORS



STANDARDBETSER STANDARD STAINS



ARTIKLAR ITEMS

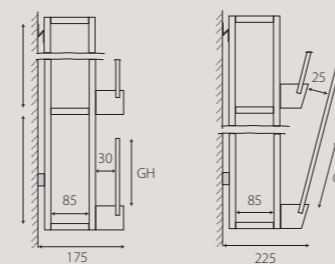
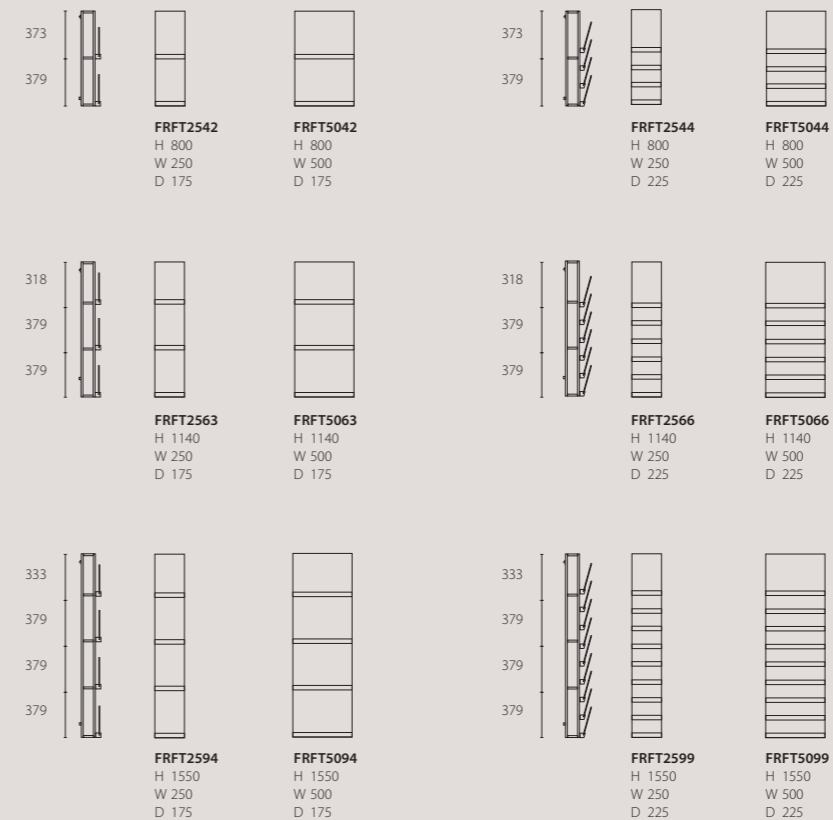

GH=Glashöjd Glass height 230 mm

TILLBEHÖR ACCESSORIES

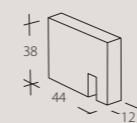

FRAV1



FRAV1



FRAV1

FRONT FRISTÅENDE FREE STANDING

UTFÖRANDE

Front fristående finns i följande tre kombinationer.

1. Utan lister med rygg i Bulletin Board 2204 eller magnetisk whiteboard inklusive magneter.
2. Tidskriftsställ med raka eller vinklade lister monterade på en eller båda sidor av ryggen.
3. Kombination med raka eller vinklade lister med rygg i trä, Bulletin Board 2204 eller magnetisk whiteboard inklusive magneter.

Härdat klarglas i höjderna 150 (=A5) och 230 (=A4) mm. Mot tillägg finns plexiglas. Utförande foten och lister är massivt trä i ek, björk, standardfärger* och standardbetser*. Ytbehandling klarlack. Specialmått och andra utförande efter förfrågan.

*Observera: För rygg i magnetisk whiteboard och Bulletin Board 2204 finns kantlist endast i trä, svart eller vit.

TILLBEHÖR

Infrästa hjul i foten. Extra magneter till whiteboard. Avdelare i massivt trä som sätts på glaset för indelning i fack.

ANGE VID BESTÄLLNING

Artikelnummer, glashöjd och utförande.

CERTIFIKATIONER/TESTER

Möbelfakta

EXECUTION

Front free standing comes in three different combinations.

1. Without ledges with back in Bulletin Board 2204 or magnetic whiteboard incl. magnets.
 2. As magazine shelf with straight or slope ledges on both sides of back.
 3. Combination of straight or sloping ledges and back in wood, Bulletin Board 2204 or magnetic whiteboard included magnets.
- Tempered clear glass in height 150 (=A5) and 230 (=A4) mm as standard. Plexi glass upon request. Base and ledges are in solid wood of oak, birch, standard colors* and standard stains*. Finish clear lacquer. Special sizes and other finishes upon request.

* Note! Edge of magnetic whiteboard and Bulletin Board 2204, on back, is only available in wood, black or white.

ACCESSORIES

Invisible castors, extra magnets for whiteboard, dividers in solid wood that slot on top of the glass fronts to divide each shelf into compartments.

WHEN ORDERING, PLEASE ENTER

Item number, glass height and execution.

CERTIFICATIONS/TESTS

Möbelfakta



ARTIKLAR ITEMS

(1) B = Bulletin Board 2204
Bulletin Board 2204

(2) T=Träpanel med lister
Wood panel included ledges

(3) W = Magnetisk whiteboard
Magnetic whiteboard

Höjd Height 1300 mm

FRDB2560⁽¹⁾ FRDW2560⁽²⁾		FRDB5060⁽¹⁾ FRDW5060⁽²⁾		FRDB10060⁽¹⁾ FRDW10060⁽²⁾		FREB2561⁽¹⁾ FREW2561⁽³⁾		FREB5061⁽¹⁾ FREW5061⁽³⁾		FREB10061⁽¹⁾ FREW10061⁽³⁾	
H 1300		H 1300		H 1300		H 1300		H 1300		H 1300	
W 250		W 500		W 1000		W 250		W 500		W 1000	
D 360		D 360		D 360		D 360		D 360		D 360	
FREB2566⁽¹⁾ FRET2566⁽²⁾ FREW2566⁽³⁾			FREB5066⁽¹⁾ FRET5066⁽²⁾ FREW5066⁽³⁾			FREB2563⁽¹⁾ FRET2563⁽²⁾ FREW2563⁽³⁾			FREB5063⁽¹⁾ FRET5063⁽²⁾ FREW5063⁽³⁾		
H 1300			H 1300			H 1300			H 1300		
W 250			W 500			W 250			W 500		
D 360			D 360			D 360			D 360		
FRDT2566⁽²⁾			FRDT5066⁽²⁾			FRDT2563⁽²⁾			FRDT5063⁽²⁾		
H 1300			H 1300			H 1300			H 1300		
W 250			W 500			W 250			W 500		
D 360			D 360			D 360			D 360		
	95										

TRÄSLAG WOOD



STANDARDFÄRGER STANDARD COLORS



STANDARDBETSER STANDARD STAINS



BULLETIN BOARD



ARTIKLAR ITEMS

(1) B = Bulletin Board 2204
Bulletin Board 2204

(2) T = Träpanel med lister
Wood panel included ledges

(3) W = Magnetisk whiteboard
Magnetic whiteboard

Höjd Hight 1750 mm

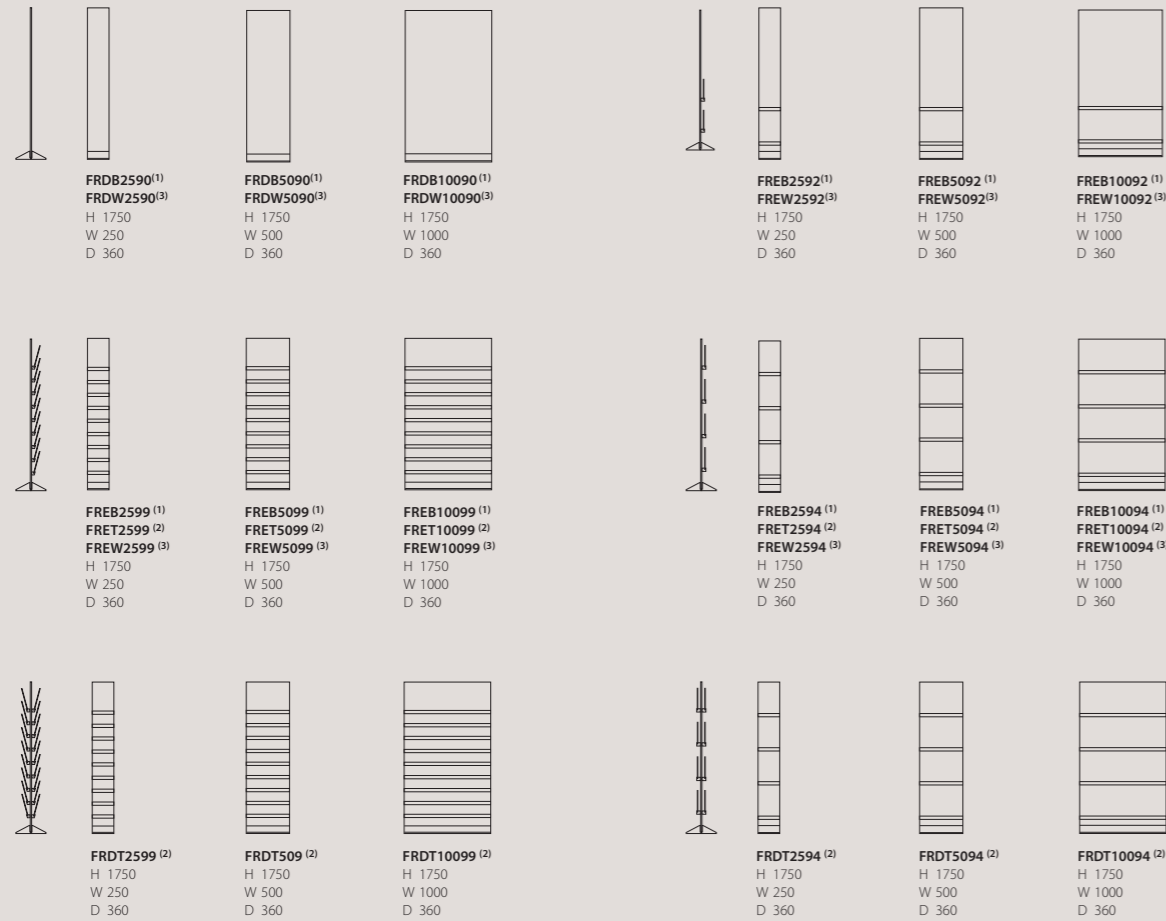

TILLBEHÖR ACCESSORIES

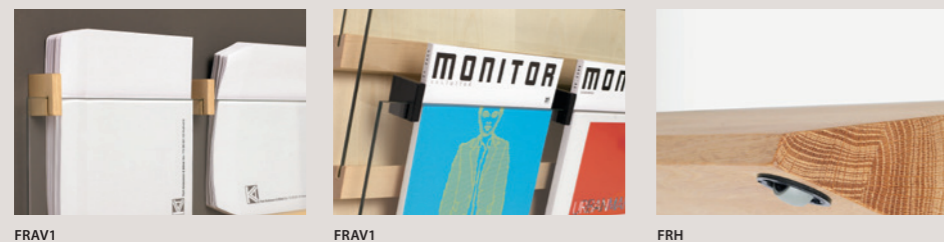

FRONT MONTERSKÅP DISPLAY CABINET

UTFÖRANDE

Skjutdörrar i härdat glas, två flyttbara glashyllplan och LED belysning. Träslagen är ek, björk, standardfärger och standardbetsar. Ytbehandling klarlack. Specialmått och andra utförande efter förfrågan.

TILLBEHÖR

Förnicketat lås.

ANGE VID BESTÄLLNING

Artikelnummer och utförande.

EXECUTION

Sliding doors in tempered glass, two adjustable glass shelves and LED light. Comes in oak, birch, standard colors and standard stains. Finish clear lacquer. Special sizes and other finishes upon request.

ACCESSORIES

Lock in nickelplated.

WHEN ORDERING, PLEASE ENTER

Item number and execution.

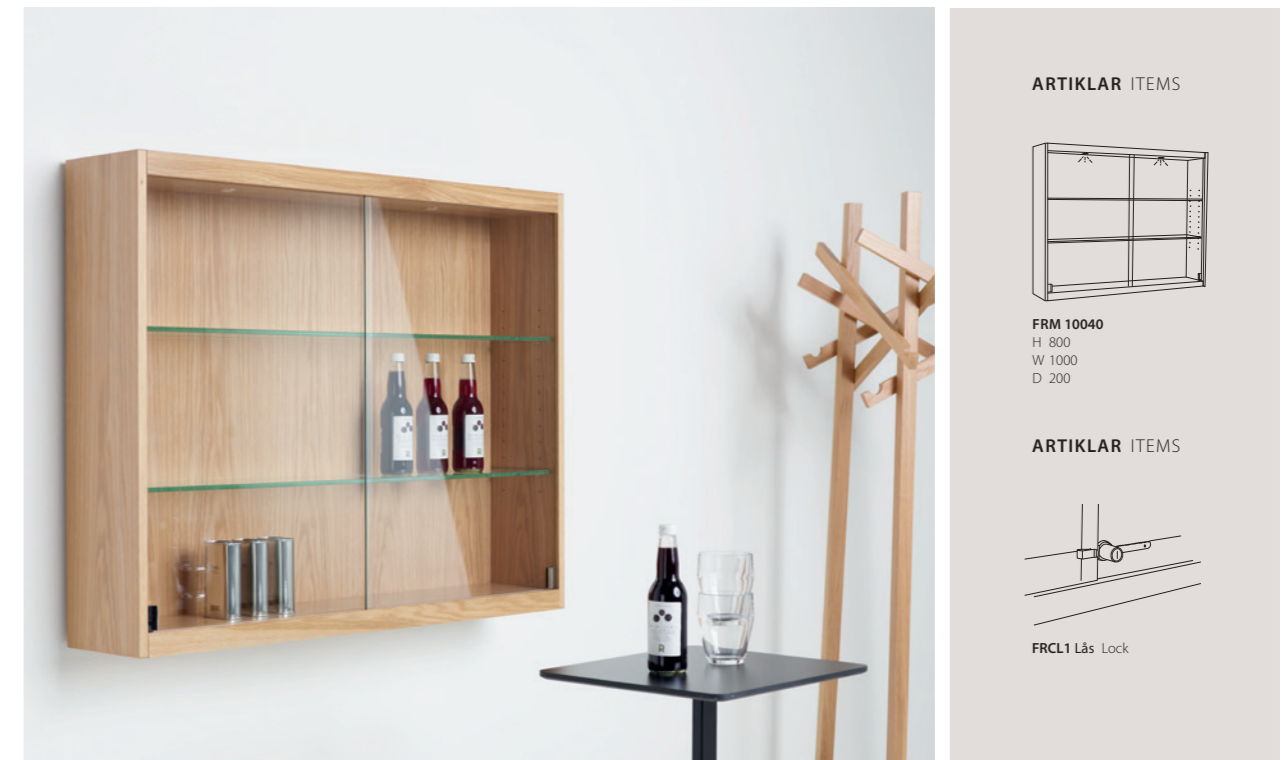

ARTIKLAR ITEMS

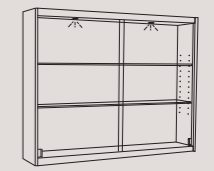

FRM 10040
H 800
W 1000
D 200

ARTIKLAR ITEMS

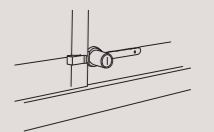

FRCL1 Lås Lock

TRÄSLAG WOOD



STANDARDFÄRGER STANDARD COLORS



STANDARDBETSER STANDARD STAINS



FRONT TAVLA BOARD

DESIGN SKALA DESIGN/LASSE PETERSSON LENNART NOTMAN, 2007

UTFÖRANDE

Används som skylt eller där du snabbt kan byta papper för olika meddelande, fotografier eller vill exponera en affisch. List och glas har tunnare dimensioner än övriga Front. Front tavla består av liggande och stående A4 och A3 som skruvas direkt på vägg. Alternativt är ett antal liggande och stående A4 som är monterat på en träpanel. På ryggen finns ett grepp som gör det enkelt att snabbt byta papper. Panel och affischtavla hängs på vägg med metallist. List i massivt trä och rygg i MDF av faner i ek, björk, standardfärger och standardbetsar på ek. Ytbehandling klarlack. Härdat klarglas som standard. Mot tillägg finns plexiglas. Specialmått och andra utförande efter förfrågan.

ANGE VID BESTÄLLNING

Artikelnummer och utförande.

EXECUTION

Wall-mounted board for use as the backing for a sign or for displaying messages and changing them quickly and easily. Front display boards are available in A4 and A3 portrait and landscape formats, secured directly to the wall. The ledge and glass are slightly thinner than in the rest of the Front range. Alternatively, a number of landscape and portrait A4 which is mounted on a wood panel. On the back there is a handle which makes it easy to change document. Panel and billboard is mounted on the wall with a metal suspension strip. Ledge in solid wood and back in MDF veneer of oak, birch, standard colors and standard stains on oak. Finish clear lacquer. Tempered clear glass as standard and plexi glass upon request. Special sizes and other finishes upon request.

WHEN ORDERING, PLEASE ENTER

Item number and execution.

ARTIKLAR ITEMS

(1) Mått affisch Dimension poster 700x500 mm

(2) Mått affisch Dimension poster 1000x700 mm



FR521
H 335
W 210
D 27



FR529
H 248
W 297
D 27



FR629
H 458
W 297
D 27



FR642
H 335
W 420
D 27



FR750⁽¹⁾
H 776
W 500
D 38



FR770⁽²⁾
H 1076
W 700
D 38



FRTL2542
H 800
W 250
D 55



FRTL5044
H 800
W 500
D 55

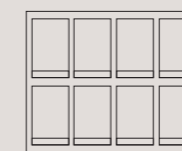

FRTL10048
H 800
W 1000
D 55

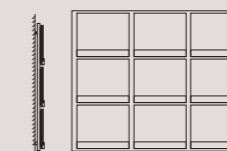

FRTL10049
H 800
W 1000
D 55



TRÄSLAG WOOD



STANDARDFÄRGER STANDARD COLORS



STANDARDBETSER STANDARD STAINS



FRONT KLÄDHÄNGARE COAT RACK

DESIGN SKALA DESIGN/LASSE PETERSSON & LENNART NOTMAN, 2004

UTFÖRANDE

List i massiv ek, björk, standardfärger och standardbetser på ek. Skruvas rakt in i vägg. Ytbehandling klarlack. Klädhängaren har från 3 upp till 20 hängare i massiv wenge.

ANGE VID BESTÄLLNING

Artikelnummer, längd och utförande på list.

EXECUTION

Solid ledge in oak, birch, standard colors or standard stains on oak, and hooks from 3 up to 20 in solid wenge wood. Finish clear lacquer. Secured directly to the wall.

WHEN ORDERING, PLEASE ENTER

Item number, length and execution on ledge.

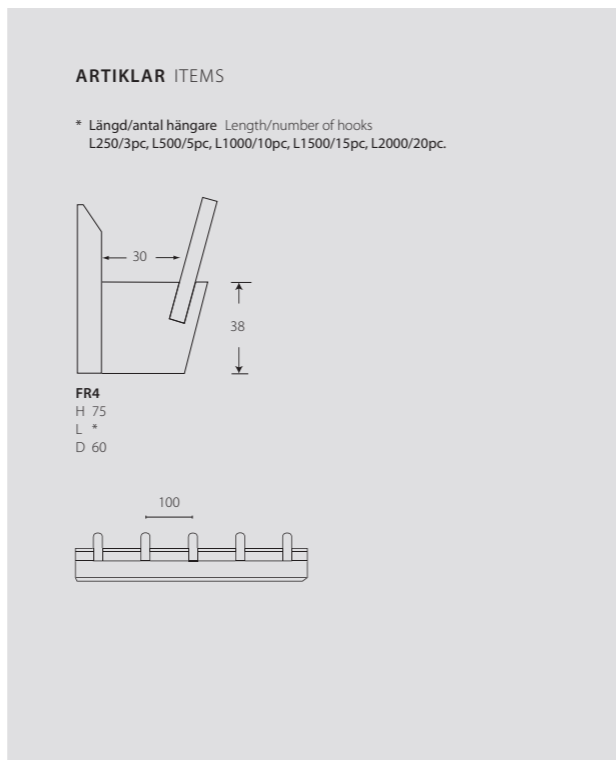

Klädhängare Coat Rack FR4150 L1500 | Hylla Shelf SIGN

TRÄSLAG WOOD



STANDARDFÄRGER STANDARD COLORS



STANDARDBETSER STANDARD STAINS



PROVER SAMPLES FRONT

Tänk på att de tryckta proverna kan skilja sig i färg, struktur och nyans jämfört med levererad produkt.
Keep in mind that the printed samples can differ in color, texture and shades compared with delivered product.

TRÄSLAG WOOD

Ytbehandling är klarlack i glansvärde 18, halvmatt. Alternativa ytbehandlingar olja, olja + lack kan erbjudas.
Treated with clear lacquer in a no. 18 semi-matt finish. Other available finishes are oil or oil + lacquer.



.10 Ek Oak



.20 Björk Birch

STANDARDFÄRGER STANDARD COLORS

Glansvärde 35, halvblank. Alternativa färger kan erbjudas enligt NCS-skalan.
Semi-gloss no. 35. Other colors are available in accordance with the NCS color system.



.62 Gul Yellow
NCS S0580-Y



.67 Röd Red
NCS 2070-Y80R



.74 Grön Green
NCS S2010-G40Y

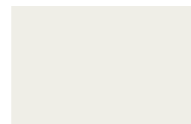

.81 Snövit Snow white
NCS S0500-N

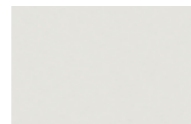

.82 Vit White
NCS 0702-Y04R

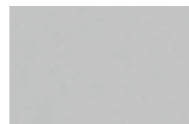

.84 Grå Grey
NCS S2500-N



.86 Antracit Anthracite
NCS S7502-B

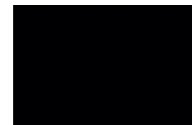

.58 Svart Black
NCS S9500

STANDARDBETSER STANDARD STAINS

Bets på ek eller ask om inget annat anges. Topplack är klarlack i glansvärde 18, halvmatt. Specialbetsar enligt insänt prov kan erbjudas.
Stain on oak or ash if not otherwise specified. Top coat of clear lacquer in a no. 18 semi-matt finish. Specialist stains in accordance with samples sent to us are also available.



.11 Svart bets
Black stain



.12 Wenge bets
Wenge stain



.13 Snövit bets
Snow white stain



.14 Rödbrun bets
Red-brown stain



.15 Grön bets
Green stain

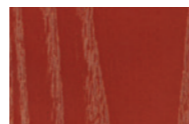

.16 Röd bets
Red stain



.17 Blå bets
Blue stain



.18 Brun bets
Brown stain



.19 Grå bets
Grey stain



.20 Antracit bets
Anthracite stain

BULLETIN BOARD

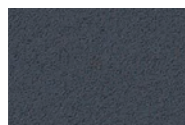

2204 NCS S6500-N
Panel, Fristående Free standing

WHITEBOARD

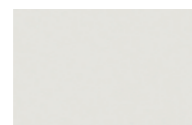

Panel, Fristående Free standing

TYG FABRIC

Europost från Gabriel
Europost from Gabriel
Panel



KARL ANDERSSON & SÖNER
SINCE 1898

HANDMADE IN HUSKVARNA. SINCE 1898.

Karl Andersson & Söner. Rosendalagatan 6, SE-561 34 Huskvarna, Sweden
+46 (0)36 13 25 30. info@karl-andersson.se

Showrooms

Studio B3. Barnhusgatan 3. Stockholm. +46 (0)8 21 42 31
Studio L6. Lasarettsgatan 6. Göteborg. +46 (0)31 13 83 90

karl-andersson.se